



23 Sandwichmagnete

Plastoneodym



Sandwichmagnete,
extra stark
120°C

Plastoferrit



Sandwichmagnete
100°C

AlNiCo



Magnetleisten
500°C

HF 28/15



Magnetrolle
150°C

Hartferrit



Kraftmagnete
100°C

AlNiCo

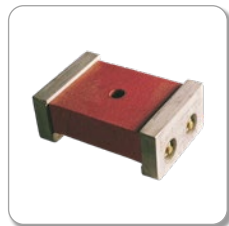

Fixiermagnete
500°C

Übersicht –
Alle Kapitel

 **Kunden-
spez. Anfrage***

***Kundenspezifische Magnetanfrage, Werkslieferung**
Abmessung / Material / Magnetisierung / Beschichtung /
Temperatur / nach Zeichnung...

**Technische
Informationen**



Sandwichmagnete, extra stark

Werkstoffe: **Plastoneodym PN60/72, Weicheisen**

Werte (10 N = ~1kg)

Temperatur: max. 120°C

Ausführung: Polplatten verzinkt

Bestell-Nr.	Gewicht	Hubkraft
	g	N
M366145	35	260

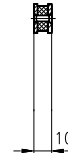
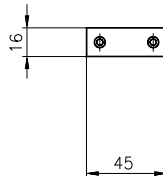

Bestell-Nr.	Gewicht	Hubkraft
	g	N
M366245	78	580

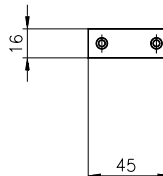

Bestell-Nr.	Gewicht	Hubkraft
	g	N
M366100	101	560

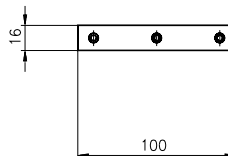

Übersicht –
Alle Kapitel

 **Kunden-
spez. Anfrage**

**Technische
Informationen**

↑ top

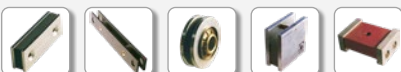



Sandwichmagnete

Werkstoffe: **Plastoferrit PF 9/21 p, Weicheisen**

Werte (10 N = ~1kg)

Temperatur: max. 100°C

Bestell-Nr.	Gewicht	Hubkraft	Polplatten
	g	N	
M141.5	35	100	verzinkt

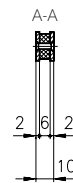
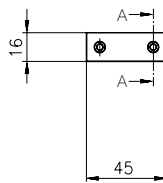

Bestell-Nr.	Gewicht	Hubkraft	Polplatten
	g	N	
M241.5	65	170	vernickelt

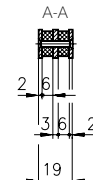
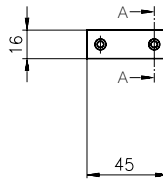

Bestell-Nr.	Gewicht	Hubkraft	Polplatten
	g	N	
M142.5	80	240	vernickelt

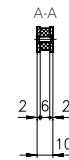
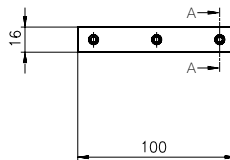

Bestell-Nr.	Gewicht	Hubkraft	Polplatten
	g	N	
M143.5	145	420	vernickelt

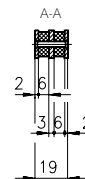
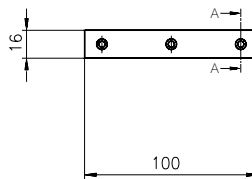

Bestell-Nr.	Gewicht	Hubkraft	Polplatten
	g	N	
M149.2	800	24 /cm	vernickelt
M249.2	1450	42 /cm	vernickelt

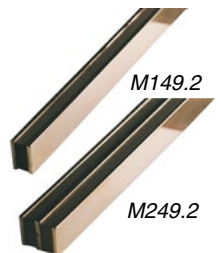
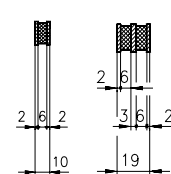
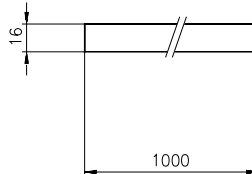

M149.2 M249.2

Übersicht –
Alle Kapitel

 **Kunden-
spez. Anfrage**

**Technische
Informationen**

↑top





Magnetleisten

Werkstoffe: **AINiCo 40/5**, Weicheisen, Messing

Werte (10 N = ~1kg)

Temperatur: max. 500°C

Ausführung: Eisenteile brüniert, genietet

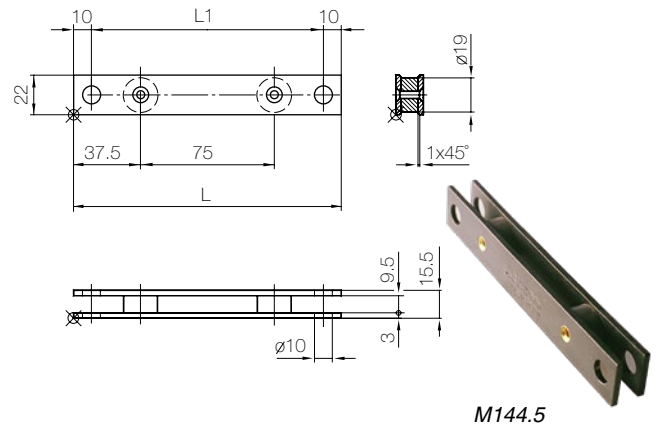

Abmessungen, mm		Bestell-Nr.	Gewicht	Hubkraft
L	L1		g	N
150	130	M144.5	179	100
300	280	M145.5	370	175

Werkstoffe: **AINiCo 40/5**, Weicheisen, Messing

Werte (10 N = ~1kg)

Temperatur: max. 500°C

Ausführung: Eisenteile brüniert, Schrauben Messing

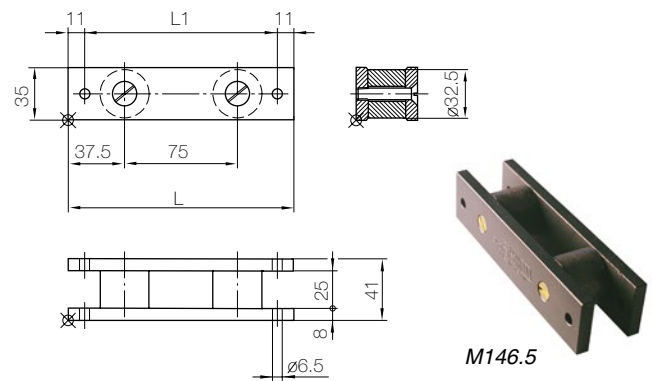

Abmessungen, mm		Bestell-Nr.	Gewicht	Hubkraft
L	L1		g	N
150	128	M146.5	940	450
300	278	M147.5	1900	800
450	428	M148.5	2850	1100

Übersicht –
Alle Kapitel

 Kunden-
spez. Anfrage

Technische
Informationen

↑ top





Magnetrolle

Werkstoffe: **HF 28/15**, Weicheisen, Messing

Werte (10 N = ~1kg)

Temperatur: max. 200°C

Ausführung: Magnet roh, Eisen promatisiert, magnetisiert.

Abmessungen, mm	Bestell-Nr.	Gewicht	Hubkraft
D H		g	N
63 30	M150.5	360	150

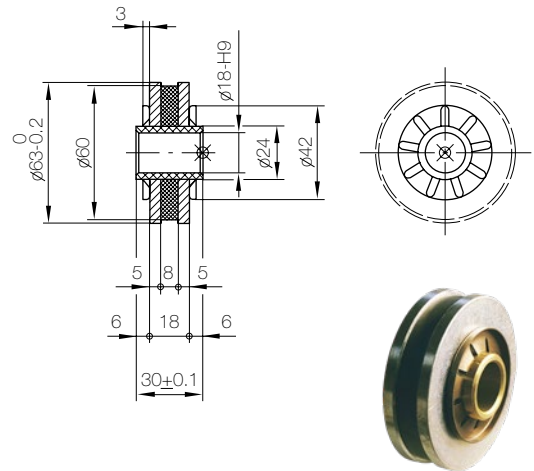

Kraftmagnete

Werkstoffe: **HF 28/26**, Weicheisen, Messing

Werte (10 N = ~1kg)

Temperatur: max. 100°C

Ausführung: Stahlteile promatverzinkt

Bestell-Nr.	Gewicht	Hubkraft
	g	N
MM2004	1462	600

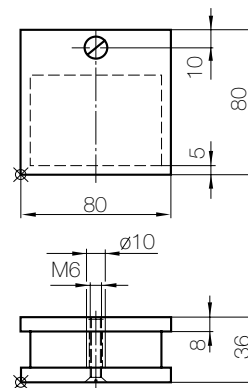

Fixiermagnet

Werkstoffe: **AINiCo 43/5**, Weicheisen, Messing

Werte (10 N = ~1kg)

Temperatur: max. 500°C

Ausführung: Magnet rot lackiert, Polschuhe cadmiert, 2 Polschlussplatten.

Bestell-Nr.	Gewicht	Hubkraft	Abmessungen, mm		
	g	N	L	B	H
M043*	1207	580	98.5	66.7	38.1

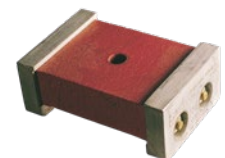

* Auslauf

Übersicht –
Alle Kapitel

 Kunden-
spez. Anfrage

Technische
Informationen

↑ top

